



OWNER'S MANUAL

This manual has been completed to help you to operate your craft with safety and pleasure.

It contains details of the craft; the equipment supplied or fitted its systems, and information on their operation. Please, read the manual carefully, and familiarize yourself with the craft before using it.

This owner's manual is not a course on boating safety or seamanship. If this is your first craft, or you are changing to a type of craft you are familiar with, for your own comfort and safety, please ensure that you obtain handling and operating experience before "assuming command" of the craft. Your dealer or national sailing federation or yacht club will be pleased to advise you of local sea schools, or competent instructors.

Ensure that the anticipated wind and sea conditions will correspond to the design category of your craft, and that your crew are able to handle the craft in these conditions.

Even when your boat is categorized for them, the sea and wind conditions corresponding to the design category C range from severe storm conditions for category, to strong conditions for the top of category C, open to the hazards of a freak wave of gust. These are therefore dangerous conditions, where only a competent, fit and trained crew using a well maintained craft can satisfactorily operate.

This owner's manual is not a detailed maintenance or trouble-shooting guide. In the case of difficulty, refer to the boat builder or his representative. If a maintenance manual is provided, use it for the craft maintenance.

Always use trained and competent people for maintenance, fixing or modifications. Modifications that may affect the safety characteristics of the craft shall be assessed, executed and documented by competent people. The boat builder cannot be held responsible for modification that he has not approved.

In some countries, a driving license or authorization are required, or specific regulation are in force.

Always maintain your craft properly and make allowance for the deterioration that will occur in the time and as a result of heavy use or misuse of the craft.

Any craft, no matter how strong it may be, can be severely damaged if not used properly. This is not compatible with safe boating. Always adjust the speed and direction of the craft to sea conditions.

The craft should have onboard the appropriate safety equipment (lifejackets, harness, etc) according to the type of craft, weather conditions, etc. This equipment is mandatory in some countries. The crew should be familiar with the use of all safety equipment and emergency manoeuvring (man overboard recover, towing etc) sailing schools and clubs regularly organize drill sessions.

All person should wear a suitable buoyancy aid (life jacket/ personal flotation device) when on the deck. Note that, in some countries, it is a legal requirement to wear a buoyancy aid that complies with their national regulations and times.

PLEASE, KEEP THIS MANUAL IN A SECURE PLACE, AND HAND IT OVER TO THE NEW OWNER WHEN YOU SELL THE CRAFT.

CONTENTS

1. Declaration of conformity	4-6
2. General	7-9
3. Assembly and disassembly	10-17
4. Safety and operation recommendations	18-25
5. Maintenance	26-27
6. Environment	28
7. Warranty	29-30
8. Specifications	31
9. Warranty Card	32

2. GENERAL

2.1 SAFETY ALERTS

This manual uses the following safety alerts to draw your attention to special safety instructions that should be followed.



DANGER - Denotes that an extreme intrinsic hazard exists which would result in high probability of death or irreparable injury if proper precautions are not taken.



WARNING - Denotes that a hazard exist which can result in injury or death if proper precautions are not taken.



CAUTION - Denotes a reminder of safety practices or direct attention to unsafe practices which could result in personal injury or damage to the craft or component or to the environment.

2.2 NATIONAL LEGISLATION

Before you prepare for the water with your BUSH inflatable, check the local legislation on any restrictions on the specific water you want to use. You might check for speed-restriction and restrictions on the use of outboard engines, restrictions on the airborne sounds, etc.

2.3 GENERAL SAFETY INFORMATION

Safe Boating Suggestions.

In order to safely enjoy the waterways, familiarize yourself with local and other governmental boating regulations and restrictions, and consider the following suggestions:



WARNING: If this boat is used around the mother ship at open sea, take the necessary precautions! Don't lose contact with the mother ship!

ALWAYS WEAR A LIFEJACKET!

Use flotation devices. Have an approved personal flotation device of suitable size for each person aboard (it is the law) and have it readily accessible.

Do not overload your boat. Most boats are rated and certified for maximum load (weight) capacities (refer to your boat capacity plate). If in doubt, contact your dealer or the boats manufacturer.

Perform safety checks and required maintenance. Follow a regular schedule and ensure that all repairs are properly made. Know and obey all nautical rules and laws of the waterways.

Make sure everyone in the boat is properly seated. Do not allow anyone to sit or ride on any part of the boat that was not intended for such use.

This includes the back of seats, gunwales, transom, bow, decks, raised fishing seats, any rotating fishing seat; or anywhere that an unexpected acceleration, sudden stopping, unexpected loss of boat control, or sudden boat movement could cause a person to be thrown overboard or into the boat.

Never be under the influence of alcohol or drugs while boating (it is the law). Alcohol or drug use impairs your judgment and greatly reduces your ability to react quickly. Prepare other boat operators. Instruct at least one other person on board in the basics of starting and operating the outboard, and boat handling, in case the driver becomes disabled or falls overboard.

Passenger boarding. Stop the engine whenever passengers are boarding, unloading, or are near the back (stern) of the boat. Just shifting the outboard into neutral is not sufficient.

Be alert. The operator of the boat is responsible by law to maintain a proper lookout by sight and hearing. The operator must have an unobstructed view particularly the front. No passengers load, or fishing seats should block the operators view when operating the boat above idle speed.

Never drive your boat directly behind a water skier in case the skier falls. . Watch fallen skiers. When using your boat for water skiing or similar activities, always keep fallen or down skier on the operator's side of the boat while returning to assist the skier. The operator should always have the down skier sight and never back up to the skier or anyone in the water.

WARNING: Do not exceed the maximum recommended number of persons. Regardless of the number of persons aboard, the total weight of persons and equipment must never exceed the maximum recommended load. Always use the seats/seating spaces provided.

Payload.

WARNING: When loading the craft never exceed the maximum recommended load. Always load the craft carefully and distribute loads appropriately to maintain design trim (approximate level). Avoid placing heavy weight high up.

Outboard engine.

DANGER: The maximum motor power of this boat is given in the specification in this manual. Overpowering a boat can result in serious injury, death or boat damage. The installation and operation instructions of the outboard motor can be found in this manual.

DANGER: You might lose control of the boat when using the motor at full speed. Accidents may occur. BUSH can not be held responsible for these actions.

3. ASSEMBLY AND DISASSEMBLY

3.1 THE VALVES

The BUSH valves are especially designed for safe and comfortable use. The valves are designed flat to increase the comfort in the boat and to prevent damage the boat.

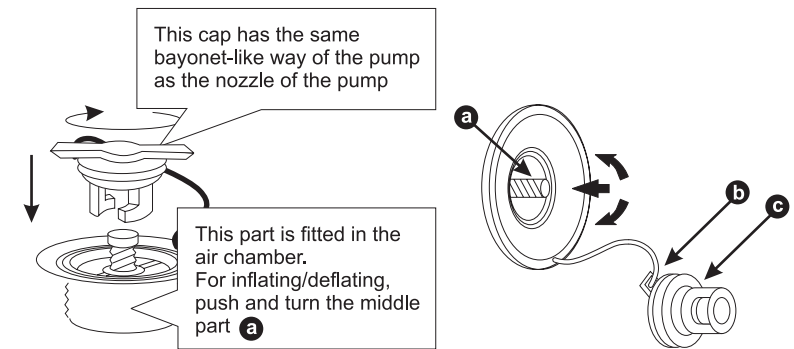

Operation of the valve:

- Take off outside cap **(b)**. The valve is closed when the middle screw **(a)** is in upside position.
- To open the valve put your finger **(a)** in the middle of the valve and push the middle screw down, turn your finger ¼ until the screw locks.
- To close the valve push the screw and turn your finger ¼ until the screw comes up

Pump connection:

- Put end piece (the nozzle fitting) of the pump on the valve.
- Turn right (clockwise) and start pumping.
- Keep pumping until no air can be put into the boat.
- When ready, be sure to take off the pump.
- Be sure to put on the protection cap again (for protection from dirt and damage).

3.2 INFLATION OF TUBE AND KEEL

Remove any sharp objects from flat surface where boat will be assembled. To inflate the boat, roll the boat out on the floor. If the boat is unpacked, check if all parts are present. Check that the valves are closed. This can be done by putting your finger in the valve, push the little colored knob in, and turn to the right one stroke. If the knob jumps up a little it is possible get air into the boat. (To let air out of the boat you have to turn the knob). Get your delivered pump. Push the nozzle, end piece on the valve and turn right. The pump will tighten on the valve. Put enough air in the boat to give the boat some form. All chambers should be inflated equally avoid damage to the bulkheads that separate the chambers.

3.3. ORDER OF INFLATION OF TUBES

CLOSE THE DIAPHRAGM OF KEEL'S VALVE BEFORE INFLATING

Inflate the boat in the following order:

1. side chambers
2. front chambers (if applicable)
3. floor chamber (if applicable)
4. keel chamber (if applicable).

ALWAYS INFLATE THE KEEL CHAMBER LAST.



CAUTION: Over-inflation can cause structural damage to your boat. Never surpass these values!

The maximum inflation pressure for the body is **0.25 bar = 3.6 psi**.

The maximum inflation pressure for the keel is **0.35 bar = 5 psi**.

The maximum inflation pressure for the floor is **0.7 bar = 10 psi**.



CAUTION: DO NOT use mechanical compressors to inflate your boat. Overinflation may result in ruptured seams and/or bulkheads. The pump that is delivered gives exactly the right pressure to your boat.

3.4 FLOOR

BUSH boats which are equipped with an inflatable or a non-inflatable floor must be operated with these floors properly installed before use. Using the boat without the provided floors unsafe, uncomfortable and may result in damage to the boat.

3.5 FLOORBOARD INSTALLATION

- Place the front section (bow board 1) of the floorboard as far in the front of the boat as possible. Make sure the hole in the bottom is straight above the valve of the keel section.
- Place part two into the boat. Put the two parts of the floorboard "in line".
- Insert the back section under transom holders.
- Push down the two parts to the bottom of the boat.
- The floorboards will be in a level position.

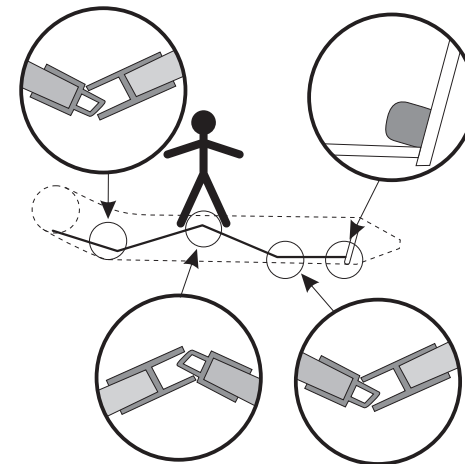

Installation of the aluminum stringer

After installation of the floorboards, put the stringers in the sides of the floor.

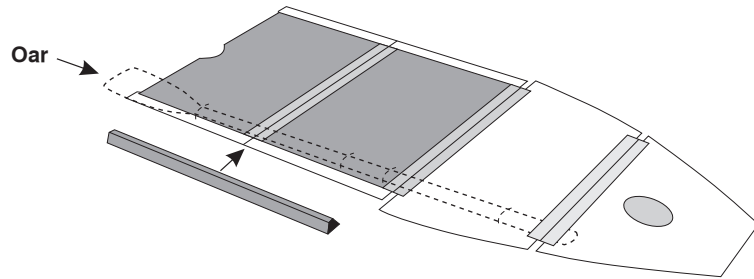

To make the installation of the stringers easier **we recommended putting an oar under the bottom** of the boat. This lifts up the floorboards to have easier access to put the stringers on the sides of the floor.

3.6 HIGH PRESSURE INFLATABLE FLOORBOARD DWF

BUSH has two types of inflatable floorboards:

Type A: This is a flat inflatable floor without any deadrise.

Type AK: Models 3D-V. This is arcuated inflatable floorboard with a deadrise. The types of inflatable floors is NOT interchangeable.

- Inflate the boat to the half of full pressure.
- Unfold and stretch out the floor onto the bottom of the boat sticking it well under the half-inflated tubes and against the transom. The valve must be face up.
- Inflate the boat.
- Close the valves by putting the caps on and turning them to the right.
- Push the sides of the floorboard under the tubes as far as possible
- Then fully inflate the inflatable floorboard.
- If you fully inflate the air deck, it will push itself underneath the tube and it will stay there tight in its place.

3.7 SEATS

If your boat is equipped with seats and a "seat rails" system on the tubes, you can install the seat bench as in the following drawing. You must install the seat after fully inflating the boat.

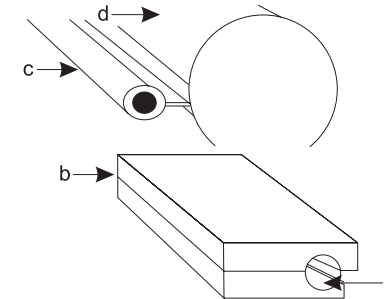

The seat rails (c) are connected to the inner sides of inflatable tubes (d) of your boat. The seat holders (b) are connected to the lower side of the seats. Insert the seat rails c into the holes a of your seat holders on the both sides of the boats equally and move the seat to the proper position.

CAUTION: NEVER use the seats for lifting your boat or as handles. The seat holders are breakable.

3.8 ROWING EQUIPMENT

BUSH boats come as standard with oars, rowlocks, and a rowing seat. Ensure seat is properly installed. To install the oars in the oarlocks, put the oars over the rowlocks pins. To prevent loss of the oars, be sure to put the cap on the rowlock. If the oars are not in use, put the oars in the clips on the sides of the boat.

CAUTION: DO NOT use the oars as levers: they are breakable!

WARNING: Local water conditions must be taken into account before operating boat with oars or a small outboard. Boat power may not be strong enough to overcome currents in tidal inlets, open seas, small channels or shallows of shoal water regions.

3.9 ENGINE INSTALLATION

Outboard power.



DANGER: Overpowering a boat can result in serious injury, death or boat damage. Using an outboard that exceeds the maximum horsepower limit of a boat can:

1. result in severe handling and/or stability problems
2. place too much weight at the transom altering the designed flotation characteristics of the boat
3. cause the boat to break apart particularly around the transom area.

The maximum motor power to be used for your boat see in specification of this manual.

Mounting the engine:

- Make sure you are standing safely and are stable.
- Unlock the motor for tilting and mount motor on the transom.
- The motor must be in the middle of the transom for proper operation.
- Screw the brackets securely on the stern.
- Lock the motor-securing line attachment.

Position of the outboard engine

The outboard motor must be so installed that in the normal running position, it stands vertically in the water. This means that the "cavitations plate" on the low side of the outboard engine is horizontal in the water if the boat is lying in its normal position. The anti-cavitations plate on the engine should be about 20 - 40 mm under the bottom of the transom.

Starting the engine

- Pull the boat into the water
- Secure the motor in the downwards position
- Stand securely and start the engine.
- Avoid very high speeds when running the boat backwards, water can come in the boat over the transom. Before putting the boat into the water check that the water plug in the transom is in place and closed.

3.10 TRANSPORTATION

3.10.1 Lifting the boat out of the water

Make sure there are no sharp edges under the boat on the place where you want to lift the boat out of the water Use the handgrips for lifting instead of the ropes and seats.

3.11 DEFLATION

General information:

NOTE: Boat should be clean and dry before rolling up for storage.

- Remove any sand and debris that may cling the fabric.
- When deflating the boat, do not deflate one chamber at once.
- Deflate all chambers evenly, this prevents damage to the bulkheads in the boat.

To deflate the boat:

Put the boat on the floor

- Put your finger in the valve and turn $\frac{1}{4}$.
- Release some air from all chambers.
- Make sure the inside of the valve stays open (to enable the air to get out during folding).
- Push evenly on the whole boat to let as much air out as possible. If you deflate and store your BUSH, you can leave the inflatable floorboard as it is installed, just leave out the air and fold the boat.

3.12 FOLDING THE BOAT

1. Put the boat on the floor.
2. Take out the floorboards.
3. Fold the boat to the middle of the boat, so that the whole boat is as wide as the transom.

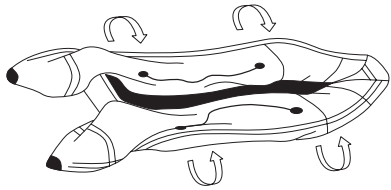

3.

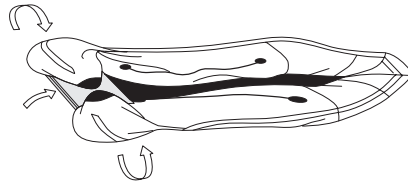

4.

4. Bring the cones at the back of the side chambers to the middle of the transom
5. Roll the transom forward. This helps to get the air out. Be sure all valves are in the open position.
6. Folded this way the boat fits in the delivered pack (sack) for transportation. If you prefer the oars to be in the same pack sack as the boat take care that the oars will not damage the pack / sack. Put in the round parts of the oars first.

4. SAFETY AND OPERATION RECOMMENDATIONS

4.1 IMPORTANT SAFETY INFORMATION

Read this:

Lanyard Stop Switch.

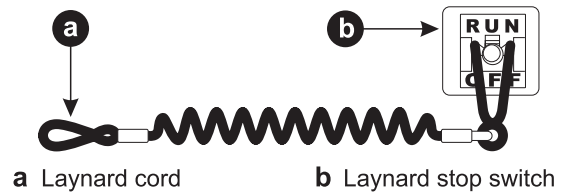

The purpose of a lanyard stop switch is to stop the engine when the operator moves far enough away from the operator's position to activate the switch. This would occur if the operator accidentally falls overboard or moves within the boat a sufficient distance from the operator's position. While activation of the lanyard stop switch will stop the engine immediately, a boat will continue to coast for some distance depending upon the velocity and degree of any turn at shut down.



WARNING: Avoid serious injury or death from deceleration forces resulting from accidental or unintended stop switch activation. Accidental or unintended activation of the switch during normal operation is also a possibility. This could cause any, or all, of the following potentially hazardous situations:

- Occupants could be thrown forward due to unexpected loss of forward motion.
- A particular concern for passengers in the front of the boat who could be ejected over the bow and possibly struck by the gear case or propeller.
- Loss of power and directional control in heavy seas, strong current or high winds.
- Loss of control when docking. The boat operator should never leave the operator's station without first disconnecting the stop switch lanyard from the operator.

4.2 PRE-OPERATING CHECK LIST

- Check the inflation pressure of the air chambers.
- Remove any obstruction from the self bailer floor drain.
- Close the self bailer floor drain.
- Check outboard for tightness on transom.
- Know the fuel capacity and cruising range.
- Check that the lanyard stop switch for the outboard works correctly.
- Be sure the boat is not overloaded. Do not exceed the maximum number of passengers or load capacity. Look at the boat capacity plate.

ALWAYS WEAR A LIFEJACKET!

- Be sure there is an approved personal flotation device of suitable size for each person aboard and readily accessible.
- Check that the paddles are in the boat in case of engine trouble.
- Operator knows safe navigation, boating, and operating procedures.
- A ring type life buoy or buoyant cushion designed to be thrown to a person in the water.
- Arrange passengers and load in the boat so the weight is distributed evenly and everyone is seated in a proper seat or on the floor.
- Instruct at least one passenger in the basics of boat handling and the starting and operation of the outboard, in case the driver becomes disabled or falls overboard.

4.3 STABILITY AND BUOYANCY

4.3.1 Position of persons and luggage

For safe operation it is advised to have people seat in the middle of the boat as much as possible. The position of the people will directly influence the stability of this craft. When operating the boat with outboard every one should be seated on the floor, neither on the side tubes nor the rowing seats, in order to prevent falling overboard.

4.3.2 Rowing

BUSH boats are designed to give you a comfortable rowing position. Use the delivered bench to make maximum use of the rowing possibilities.



WARNING: NEVER use the oars as levers they are breakable!

4.3.3 Under engine power

The bottom of your BUSH is designed to have a “V” shape (except the model type S and A). This improves the sailing characteristics, especially when operating an outboard engine. It is possible to get your BUSH boat onto the plane.



CAUTION: While you are sailing at high speed or in “aquaplaning”: avoid abrupt corners and high waves, this might endanger the passengers. Make sure everybody holds on to the safety ropes or handles. For comfort and safety, reduce speed in waves. Small children must be sitting in the boat.



WARNING: ALWAYS WEAR A LIFEJACKET!

Wave And Wake Jumping: Operating recreational boats over waves and wake is a natural part of boating. However, when this activity is done with sufficient speed to force the boat hull partially or completely out of the water, certain hazards arise, particularly when the boat re-enters the water.

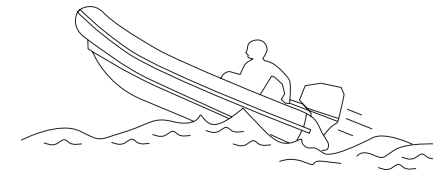

There is another less common known hazardous result from allowing your boat to launch off a wave or wake. If the bow of your boat pitches down far enough while airborne, upon water contact it may penetrate under the water surface and submarine for an instant. This will bring the boat to a nearly instantaneous stop and can send the occupants flying forward. The boat may also steer sharply to one side.

When accelerating with the boat, the bow can make an upward movement. This might limit the sight of the coxswain temporarily. When the speed of the boat increases, the boat will come back to a level position again. If the wind blows towards you when running, a bow pointed upwards can cause the wind lift the front of the boat up.

4.3.4 Single Operation

When operating under power without passengers, sit not on inflation tubes or seat, weight should be as far forward and in the middle as practical. Avoid heavy weights near the transom. Rapid acceleration should be avoided to prevent the possibility of backward flipovers.

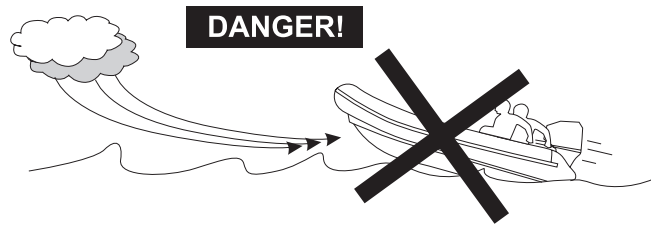

Wind and wave conditions can be highly dangerous for your inflatable. You can easily be flipped over if the load in the boat is not distributed in the bow of the boat and wind and tide are against. Especially the models with inflatable floor should be driven carefully in headwind and waves.

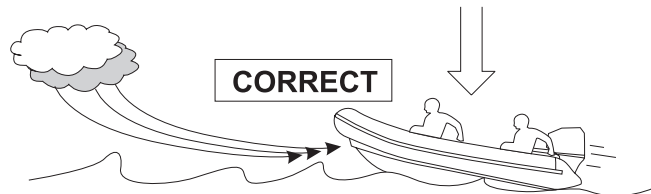

Distribution of load and weight take the bow down to a safe situation. The anti-cavitations plate on the engine should be about 30-50 mm under the bottom of the transom.

If your outboard is too high on the transom, you will experience a lot of cavitations (air bubbles and slippage around the propeller). If your outboard is too low on the transom it will create drag and it will throw up water into the boat. In both cases you end up with loss of speed, so try to find the ideal position before you finally bolt your engine to the transom (consult your engine supplier).

At all speeds it is advisable to keep the boat level. Prevent the bow from pointing up, and prevent the bow from pointing down towards the water. Use the weight of the people on board to achieve the level position. Adjust your engine angle (see below)

REMEMBER:

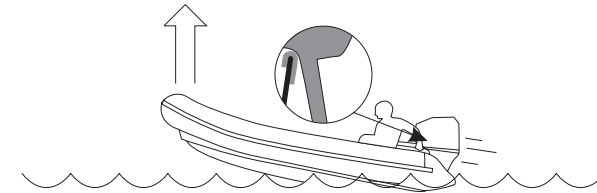

- An outboard tilted too far from the transom will drive the boat with a bow up attitude which is both very dangerous and inefficient.

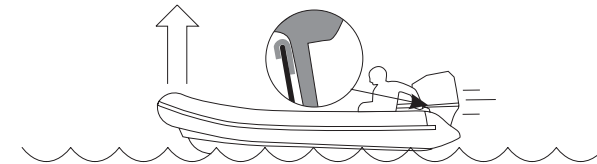

An outboard tilted too close to the transom will drive the bow section too deep into the water which ends up in loss of speed and/or cavitation.

1. Occasional checks should be made to the motor attachment screws. Loose screws will cause erratic boat operation and possible loss of engine overboard.
2. Make a thorough review of the motor's manual before operation.
3. On board loads should be monitored to avoid chaffing or puncturing the boat's skin.

4.3.5 Turning the boat

When taking a sharp turn, reduce the speed of your boat. The boat will tilt considerably inside towards the turning centre.

4.3.6 Towing the boat

If the boat is to be towed by another boat, the boat must be empty. Remove outboard, fuel tank and equipment



WARNING:

- Never tow your craft with people aboard.
- Frequently inspect the towing painter.
- Periodically check the towing conditions and especially that the craft is not taking in water.

IMPORTANT: The bow lifting handle should not be used for towing, anchoring, or mooring. Use the port and starboard points of the boat for towing. Towing this way makes the boat steady and secure behind the towing boat, and helps to avoid damage to your BUSH. Attach the towing ropes as in the following scheme:

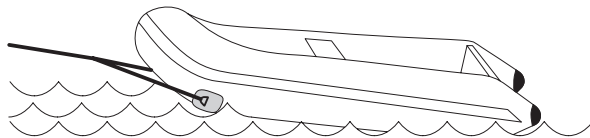

The RIB may be towed for bow ring.

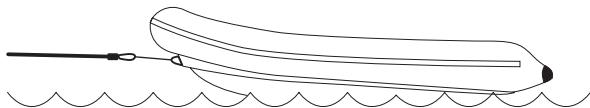

4.4 HAZARDS

4.4.1 Water hazards

1. Wrecks, reefs, rocky shores, sand bars, and shallows should be avoided or approached with caution.
2. When boating in unfamiliar waters, obtain information on local water hazards before launching.
3. **BEWARE OF OFFSHORE WINDS AND CURRENTS.**

4.4.2 Air chamber failure

Your BUSH is designed with more than one air chamber. Therefore, in the event of one of the air chambers leaking owing to a puncture, the boat will save at least 50 % of the buoyancy. Shift the weight to the opposite side. Secure the leaking chamber as necessary (by tying-up or holding-up) and immediately proceed to the nearest shore or mother ship, whichever is nearest. However, be careful about shallows or reefs, because they can scratch or further damage your boat.

4.4.3 Beaching

It is recommended that the boat not be powered onto the beach, dragged across rocks, sand, gravel or pavement as damage to the boat skin may result.

4.4.4 Davits

If the boat is suspended on davits, remove the drain plug so that no water can accumulate inside the boat.

Drain plug

The Rib is equipped with a hull/ cavity drain plug. Both must be installed when launching the boat. The hull cavity plug should be removed periodically to eliminate water from condensating in the inner hull. The deck drain plug should be removed only when the boat is under power in forward motion or when the boat is stored out of the water on davits boat storage racks exposed to rain and water.

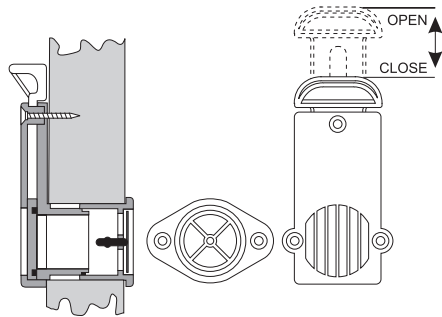

4.4.5 Sunlight

Avoid exposure to the sun for prolonged periods. The changing air pressure inside the tubes might cause damage to your boat. Extreme sunshine (ultra-violet rays) over a long period of time may accelerate ageing of the materials. Cover the boat to block direct sunlight exposure if the boat is to be removed from water for an extended period.

4.4.6 Smoking

Refrain from smoking especially while refueling your boat.

When refueling, always stick to the following recommendations:

- If possible, remove portable tanks from the craft to refuel.
- Refuel the tanks in the open air, far from heat sources, sparks or flames.
- Do not fill the tanks to the brim. The fuel increases IN volume with a rise in temperature and there is a possibility of the tank overflowing or even breaking.

4.4.7 High altitude use

Normal full inflation pressure is 250 mbar. If boat is inflated at sea level (low altitude) and transported to a high altitude (i.e., for use in a mountain lake) the air pressure must be reduced at the higher altitude to prevent over inflation.

4.4.8 Swimming



DANGER! Stop the propeller of your outboard engine when people are swimming close to your boat. The propeller can be extremely dangerous to anyone or anything in the water.

Stop the outboard motor immediately if you spot swimmers in the vicinity of your boat.

5. MAINTENANCE

5.0 GENERAL MAINTENANCE

5.1 CLEANING AGENTS

Household cleaners should be used sparingly and not discharged into waterways. Never mix cleaners and be sure to use plenty of ventilation in enclosed area. **DO NOT** use strong detergents, solvents or products which contain phosphates, chlorine, solvents, no biodegradable or petroleum based products.

Citrus based cleaners are excellent for marine cleaning purposes and are safe for you and the environment. Cleaning your Lodestar can best be one with just clean water and normal soap.

IMPORTANT: Waxes or cleaners containing alcohol or hydrocarbons should not to used on the boat fabric. These products will prematurely dry out or damage the boat fabric.

5.2 REPAIRS



WARNING! Avoid serious injury or death from a fire, explosion or poisoning. The glues and solvents used for repairing inflatable are toxic and highly flammable. As a safety precaution, always work outdoors or in an area that is well ventilated, and away from any open flames, sparks, or appliances equipped with pilot lights. Breathing the vapors or exposure to the skin may be hazardous to your health. Avoid breathing the vapors and contact with skin and eyes by wearing a carbon filter respirator and protective gear over all exposed areas of the body.

5.2.1 Small repairs

If you have any damage to your BUSH, we strongly recommend to your refer to your BUSH dealer. If the damage is a small puncture you can use the material you find in the repair kit. For the best results when gluing, the relative humidity should be less than 60%, ambient air temperature should be between 18 °C to 25 °C and not in direct sunlight.

In general, work as follows:

- Cut out a patch large enough to overlap the damaged area by 30 mm from all sides.
- Centre the overlapping patch over the damaged area and trace with a pencil the outline of the patch.
- Clean the surroundings of the puncture and the patch with solvent.
- Apply two thin layers of adhesive using a short bristle brush, in a circular pattern on both the backside of the patch and the patch area on the boat. Allow the first layer to dry completely (approximately 15 minutes) before applying the second layer. The second layer should dry until tacky, then apply the patch to the prepared area and press down firmly. Using a smooth object (the back of a tablespoon works well), force out any air bubbles that may have been trapped under the patch, working from the centre of the patch to the outside.
- Wait 24 hours before you inflate the boat again.

5.2.2 Large repairs

Larger areas or, if the parts overlaps a seam, should be patched by a professional repair technician at an inflatable repair station. Contact your local BUSH dealer for the nearest inflatable repair station.

5.2 (WINTER) STORAGE

IMPORTANT: To prevent hull or tube discoloration from marine growth or polluted waters, do not store boat in the water for extended periods of time.

1. After use, the boat and all components should be washed with a mild soap and rinsed with fresh water. Dry all parts before storage in the carrying bag. This will help prevent mould or mildew.
2. Wood components should be inspected for damage or deterioration of the finish. Surface scratches or abrasions should be refinished with a marine grade varnish.
3. To keep the boat looking new, store the boat in a cool dry area and avoid excess exposure to direct sun light.

6. ENVIRONMENT

6.1 DISCHARGE OF POLLUTANTS AND DISPOSAL OF WASTE

Prevent pollutants REACHING the water around your boat. Using the water for water sports also means taking care of a clean water sports environment. Waste means all forms of garbage, plastics, recyclables, food, wood, detergents, sewerage and even fish parts in certain water – in short, nearly everything. We recommend you bring back everything you take out with you for proper disposal ashore. Many areas prohibit the discharge of sewerage overboard or even an operable overboard waste discharge.

6.2 ADVISABLE SPEEDS

When running, take care at high speed this maybe dangerous:

- yourself or anyone or anything in the water in front of you.
- cause considerable waves behind the boat which damages the water-front.
- cause unnecessary noise to fellow water sporters.

6.3 EXCESSIVE NOISE

Noise means engine noise or even yelling. Many bodies of water have adopted noise limits. Don't use thru-transom exhaust unless you're well off-shore. Music and loud conversation can carry a considerable distance on water, especially at night.

6.4 EXHAUST EMISSIONS

Increased exhaust (hydrocarbon) emissions pollute our water and air. Keep your engine tuned and boat hull clean for peak performance. Consult your dealer and engine manual for information.

7. WARRANTY

LIMITED WARRANTY

- I. We warrant each new production BUSH inflatable boat and accessories attached thereto (hereafter referred to as "Product") to be free from defects in material and workmanship, but only when the consumer sale is made in a country to which distribution is authorized by us.
- II. The warranty shall become effective only upon receipt of a completed Warranty Card or digital registration confirmation, which shall identify the product so registered by serial number.

This warranty shall remain in effect as described below.

- A. Hull coated fabric is covered by a 5 year warranty against cracking, porosity and rot.
- B. Hull seams are covered against delaminating by a limited 5 year warranty.

NOTE: Seams are determined to have delaminated when the outer coating separates from the fabric base or the seam loses its structural strength. If delamination is occurring on only one seam and not on the entire boat, the seam is to be repaired under warranty.

- C. All other boat parts, including but not limited to components such as fiberglass hull, oars, oar locks, lifting handles, foot pumps, oars, boat bag, transom holder, transom, "D" rings, stringers, "H" fittings, floor boards, rubbing strake and all other components are covered by a limited 2 years warranty.
- III. Since this warranty applies only to defects in material and workmanship, it does not apply to normal wear and tear, or to damage caused by:
 - A. Neglect, lack of maintenance, accident, abnormal operation or improper installation or services;
 - B. Use of an accessory or part not manufactured or sold by us;
 - C. Participating in or preparing for racing or other competitive activity;
 - D. Alteration or removal of parts.
- IV. This warranty does not cover incidental or consequential costs or expenses such as: haul-out, launch, towing transport and storage charges; telephone or rental charges of any type, inconvenience, or loss of time or income; or other consequential damages. or loss of time or income; or other consequential damages.

- V. Customer must provide reasonable access to the product for warranty service by delivering the product for inspection to a BUSH dealer authorized to service the purchaser's product. If a purchaser cannot deliver product to such authorized dealer, they may give notice in writing to the company. We shall then arrange for the inspection and repair, provided such service is covered under this warranty. Purchaser shall pay for all related transportation charges and/or any other expenses associated with that service. Any product or parts shipped by purchaser for inspection or repair must be shipped with transportation charges prepaid. The Warranty Registration Card is the only valid registration identification and must be presented at the time warranty service is required. Warranty claims will not be accepted without presentation of the Warranty Card.
- VI. Our obligation under this Warranty shall be limited to repairing a defective part, or at our option, refunding the purchase price or replacing such part or parts as shall be necessary to remedy any malfunction resulting from defects in material or workmanship as covered by this Warranty. We reserve the right to improve the design of any product without assuming any obligation to modify any product previously manufactured.
- VII. This warranty gives you specific legal rights, and you may also have other legal rights which vary from country to country.

8. SPECIFICATION

Model	Lenght overall, m	Beam overall, m	Lenght inside, m	Beam inside, m	Tube diameter, m	No of chamber	Floor type	Total weight, kg	Max. load, kg	Max. No of persons	Max. engine size, kW/hp	Design category
VENTA												
V - 270	2.70	1.06	2.00	0.44	0.31	2 + 1	Inflat.	21	210	2	-	D
V - 300	3.00	1.40	2.30	0.58	0.41	2 + 1	Inflat.	26	420	3+1	-	D
RAFT												
R - 345	3.45	1.42	2.68	0.58	0.42	2 + 1	Inflat.	33	620	6	1.6/2.2	D
MURENA												
M - 285	2.85	1.46	2.10	0.62	0.42	2	Slatted	34	550	4 + 1	1.6/2.2	D
SKATE												
S - 315	3.15	1.48	2.02	0.68	0.40	3 + keel	Rigid	53	475	4	11/15	C
S - 350	3.50	1.66	2.37	0.78	0.44	3 + keel	Rigid	68	600	6	15/20	C
S - 380	3.80	1.90	2.53	0.88	0.51	3 + keel	Rigid	79	870	6 + 1	18.4/25	C
S - 410	4.10	1.90	2.78	0.88	0.51	3 + keel	Rigid	86	950	7	22/30	C
KAIMAN R												
K - 285 R	2.85	1.32	2.00	0.60	0.36	3 + keel	Rigid	50	400	4	3.3/4.5	D
K - 300 R	3.00	1.47	2.10	0.75	0.36	3 + keel	Rigid	54	424	4+1	11/15	C
K - 330 R	3.30	1.53	2.35	0.73	0.40	3 + keel	Rigid	58	580	5	15/20	C
K - 360 R	3.60	1.70	2.50	0.78	0.46	3 + keel	Rigid	69	750	5+1	18.4/25	C
KAIMAN S												
K - 245 S	2.45	1.32	1.72	0.60	0.36	3	Slatted	29	350	3	2.9/4	-
K - 265 S	2.65	1.32	1.90	0.60	0.36	3	Slatted	30	380	4	3.3/4.5	D
K - 285 S	2.85	1.32	2.00	0.60	0.36	3	Slatted	33	400	4	3.3/4.5	D
KAIMAN AK												
K - 285 AK	2.85	1.32	2.00	0.60	0.36	3+1	DWF	33	400	4	2.2/3	D
K - 300 AK	3.00	1.47	2.10	0.75	0.36	3 + 1	DWF	41	424	4 + 1	7.3/9.9	C
K - 330 AK	3.30	1.53	2.35	0.73	0.40	3 + 1	DWF	48	580	5	11/15	C
K - 360 AK	3.60	1.70	2.50	0.78	0.46	3 + 1	DWF	55	750	5 + 1	15/20	C
FAVORIT												
F - 370	3.70	1.85	2.42	0.85	0.50	3 + keel	Rigid	77	840	6	18.4/25	C
F - 400	4.00	1.85	2.70	0.85	0.50	3 + keel	Rigid	81	870	7	22/30	C
F - 420	4.20	2.05	2.90	1.05	0.50	5 + keel	Rigid	90	904	10	25.7/35	C
F - 470	4.70	2.05	3.40	1.05	0.50	5 + keel	Rigid	110	1021	12	29.4/40	C
CRAB												
K - 285 R	2.85	1.32	2.00	0.60	0.36	3 + keel	Rigid	50	400	4	3.3/4.5	D
K - 300 R	3.00	1.47	2.10	0.75	0.36	3 + keel	Rigid	54	424	4+1	11/15	C
K - 330 R	3.30	1.53	2.35	0.73	0.40	3 + keel	Rigid	58	580	5	15/20	C
K - 360 R	3.60	1.70	2.50	0.78	0.46	3 + keel	Rigid	69	750	5+1	18.4/25	C
K - 400 R	4.05	1.90	2.88	0.90	0.50	3 + keel	Rigid	79	1000	7	22/30	C
CLASSIC RIB												
C - 300 RIB	3.00	1.46	2.23	0.66	0.40	3	Fibergl.	62	450	5	9/12	C

9. WARRANTY CARD

Model	
Serial No.	LV-BSH

PURCHASER'S DATA

Names	
Address	
Z.I.P. Code	Town
Country	Phone

DATE OF PURCHASE	DEALER'S STAMP

"BUSH" Ltd., Riga, Latvia
 www.bushboats.com
 www.bush.lv
 e-mail: bush@bushboats.com
 bush@bush.lv